





Příloha č.1 k prohlášení vlastníka domu č.p.517 na jednotky

ČÍSLO POPISNÉ: 517

ULICE: SARATOVSKÁ

KAT.ÚZEMÍ: STRAŠNICE

OBEC: PRAHA 10

	- BYTOVÉ JEDNOTKY
	- SPOLEČNÉ PROSTORY
	- BEZPŘÍJAZDOVÉ PLOCHY
	- NIBYTOVÝ PROSTOR
	- BALKONY, TERASY

**1.P.P.
Saratovská 19**

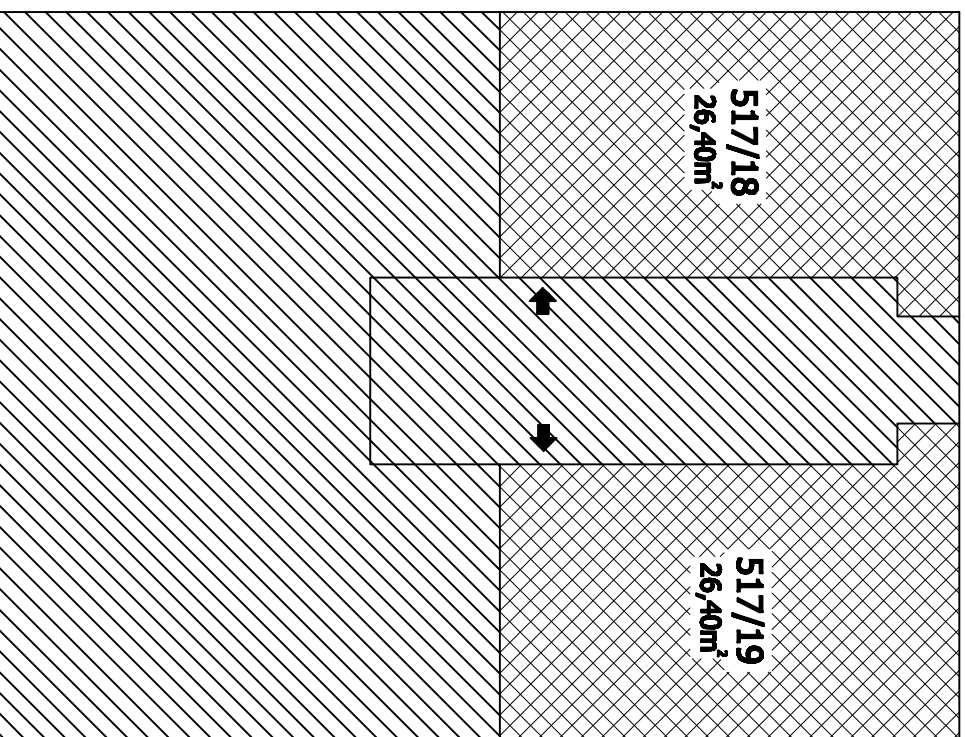

**1.N.P.
Saratovská 19**

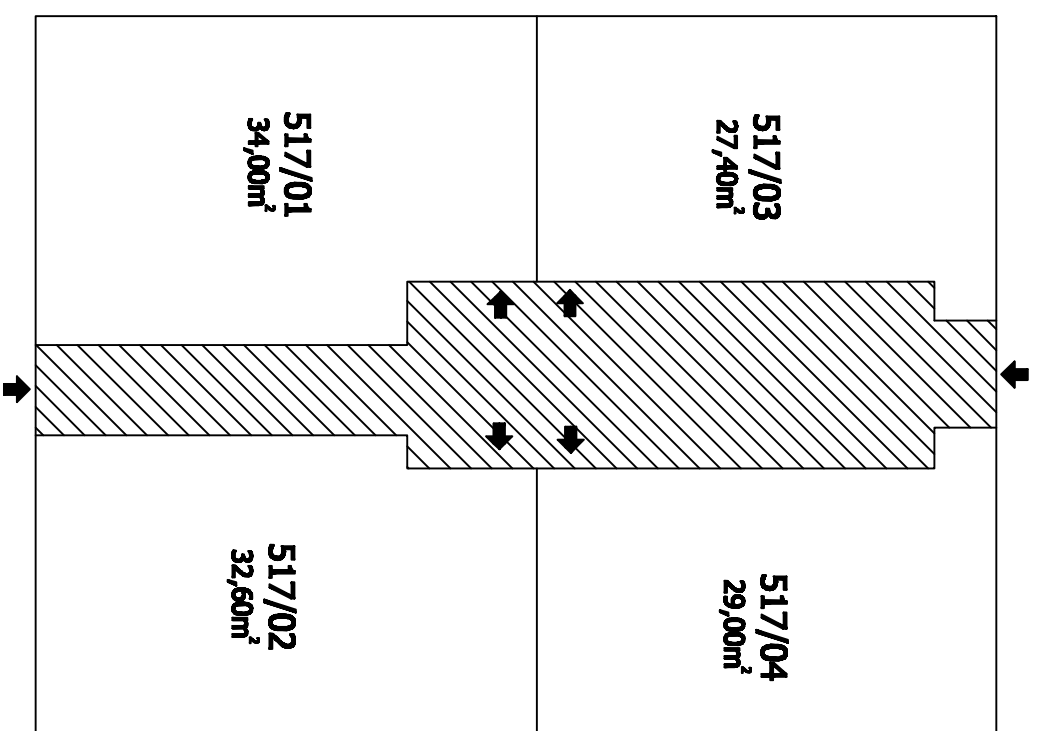

**2.N.P.
Saratovská 19**

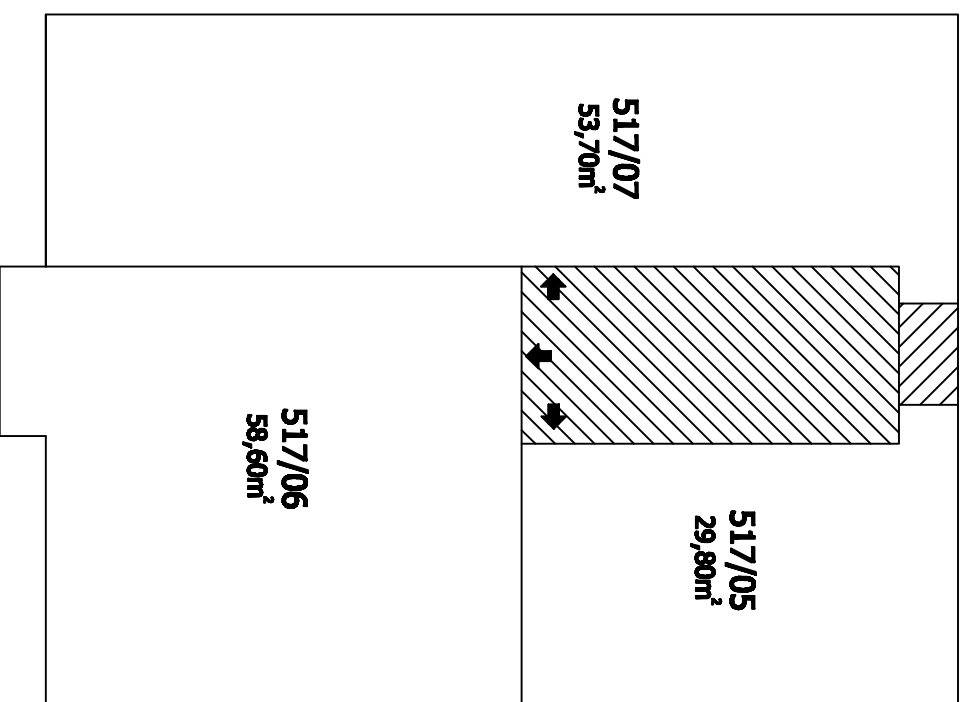

**3.N.P.
Saratovská 19**

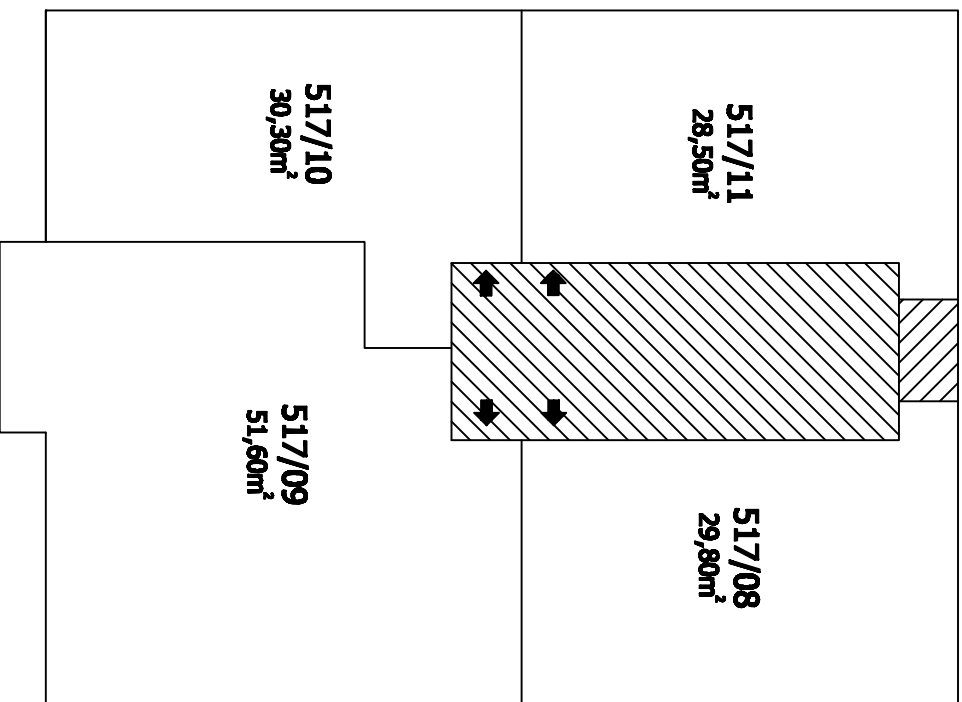

**4.N.P.
Saratovská 19**

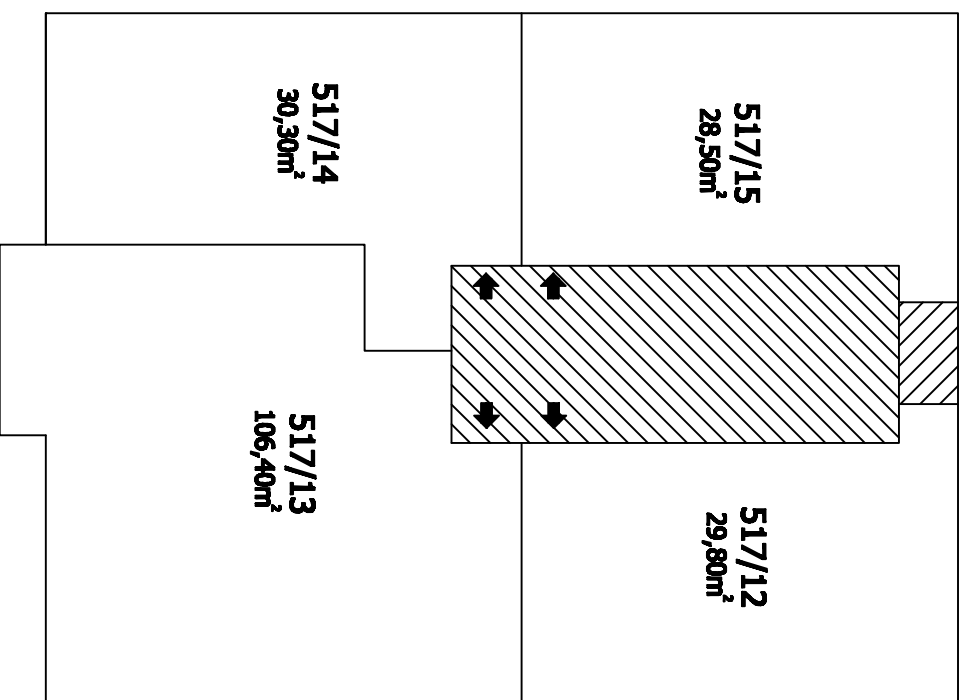

**5.N.P.
Saratovská 19**

