





Příloha č.1 k prohlášení vlastníka domu č.p.731 na jednotky

ČÍSLO POPISNÉ: 731

ULICE: NA SPOJCE

KAT.ÚZEMÍ: VRŠOVICE

OBEC: PRAHA 10

	- BYTOVÉ JEDNOTKY
	- SPOLEČNÉ PROSTORY
	- BEZPODLAHOVÉ PLOCHY
	- NEBYTOVÝ PROSTOR
	- BALKONY, TERASY

**2.P.P.
Na Spojce 1**

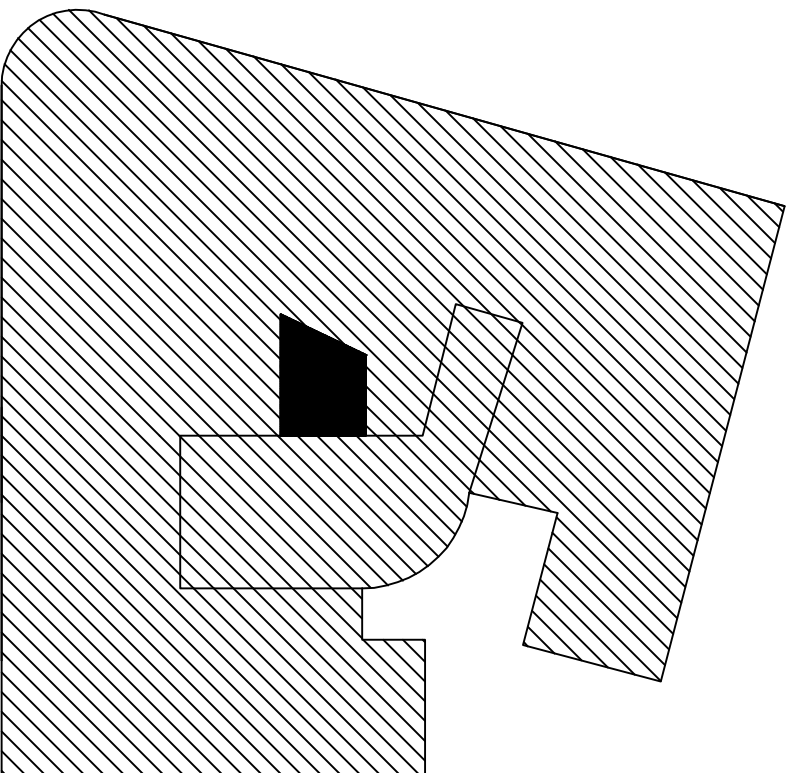

**1.P.P.
Na Spojce 1**

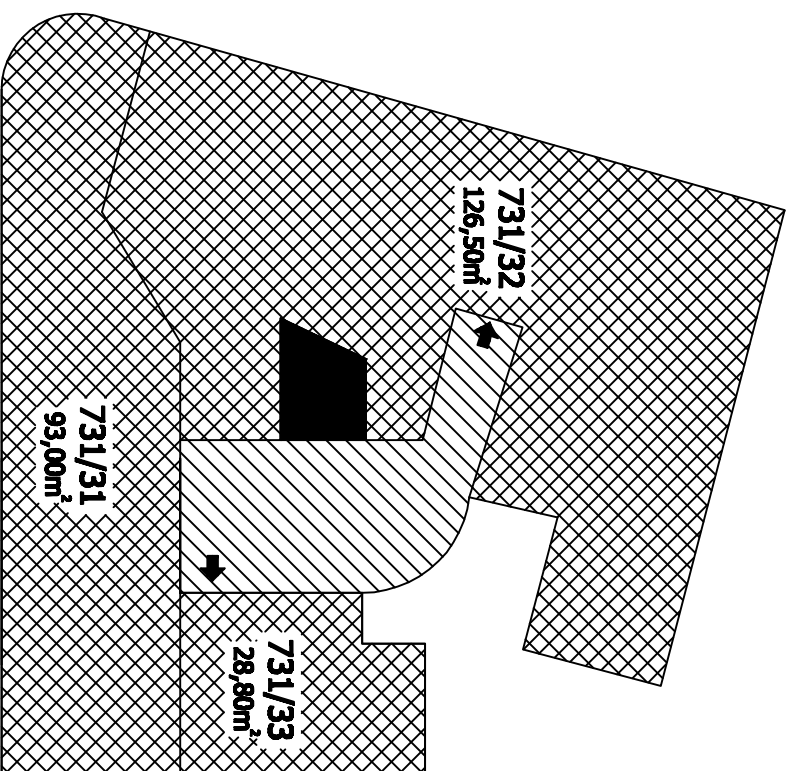

**1.N.P.
Na Spojce 1**

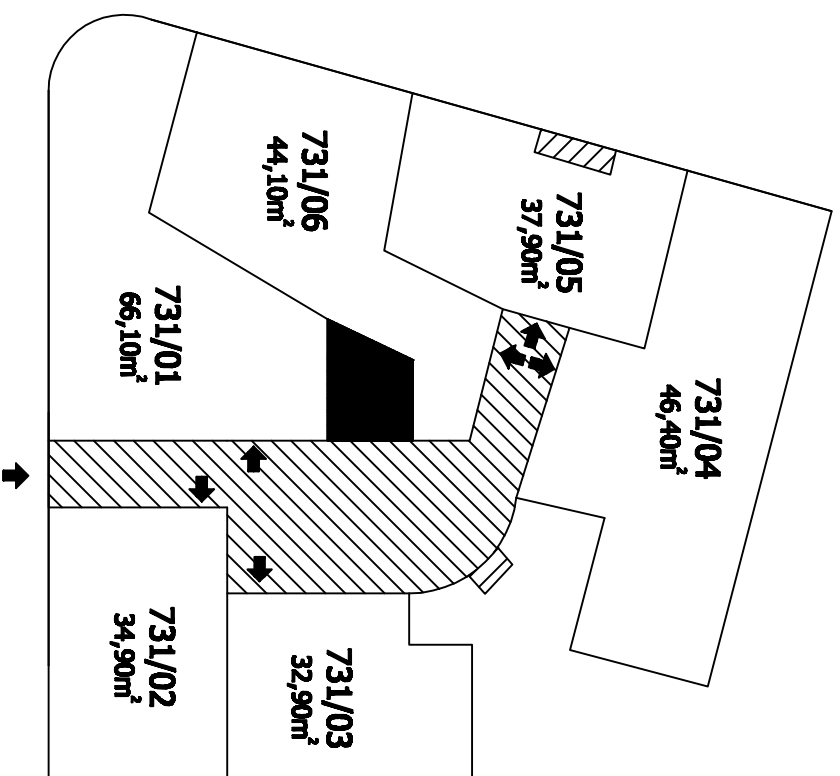

**2.N.P.
Na Spojce 1**

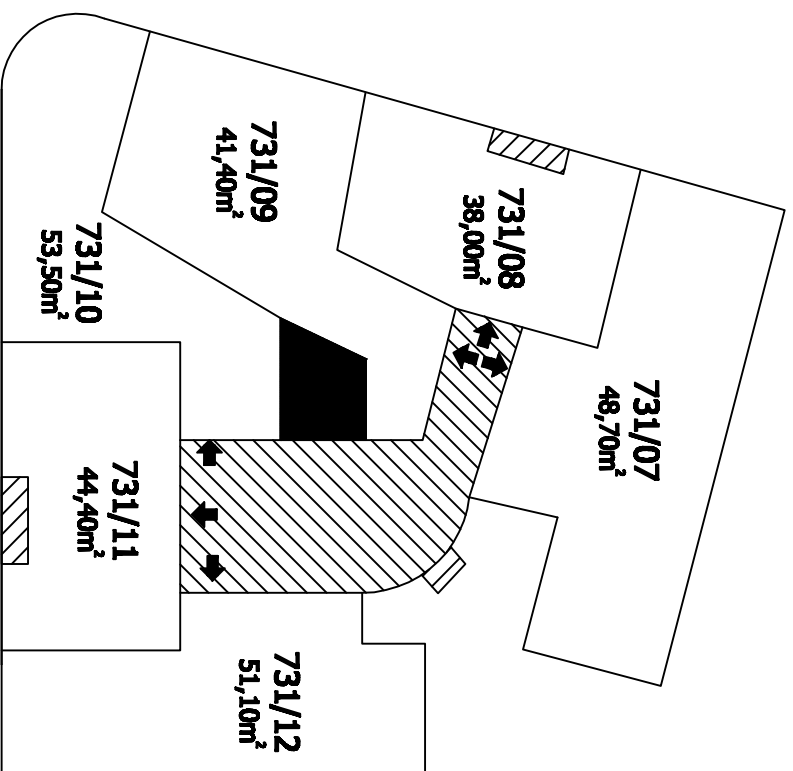

**3.N.P.
Na Spojce 1**

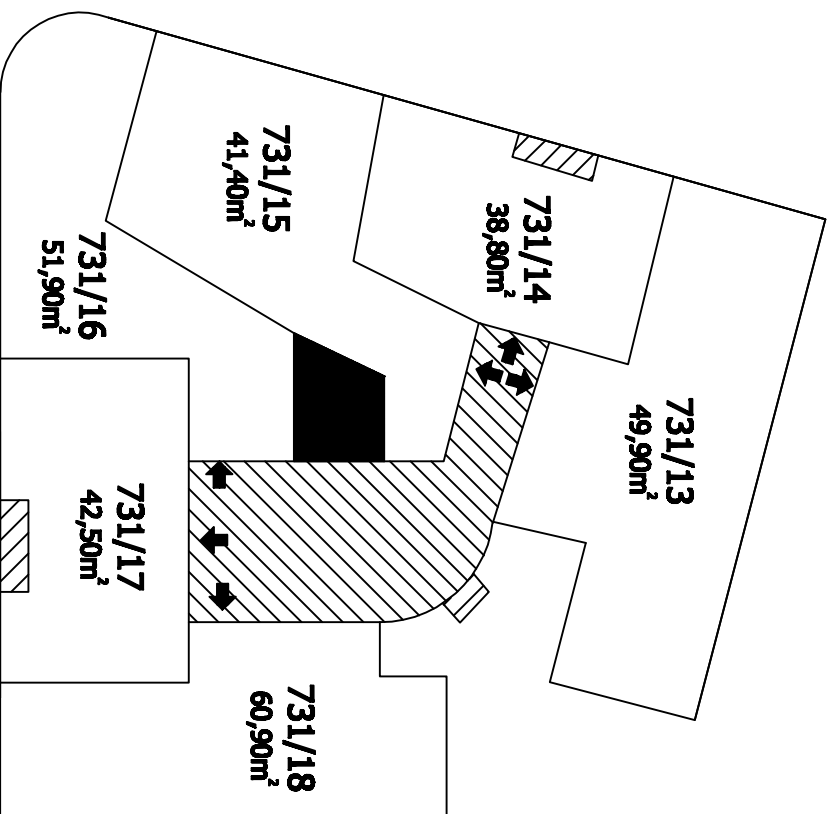

**4.N.P.
Na Spojce 1**

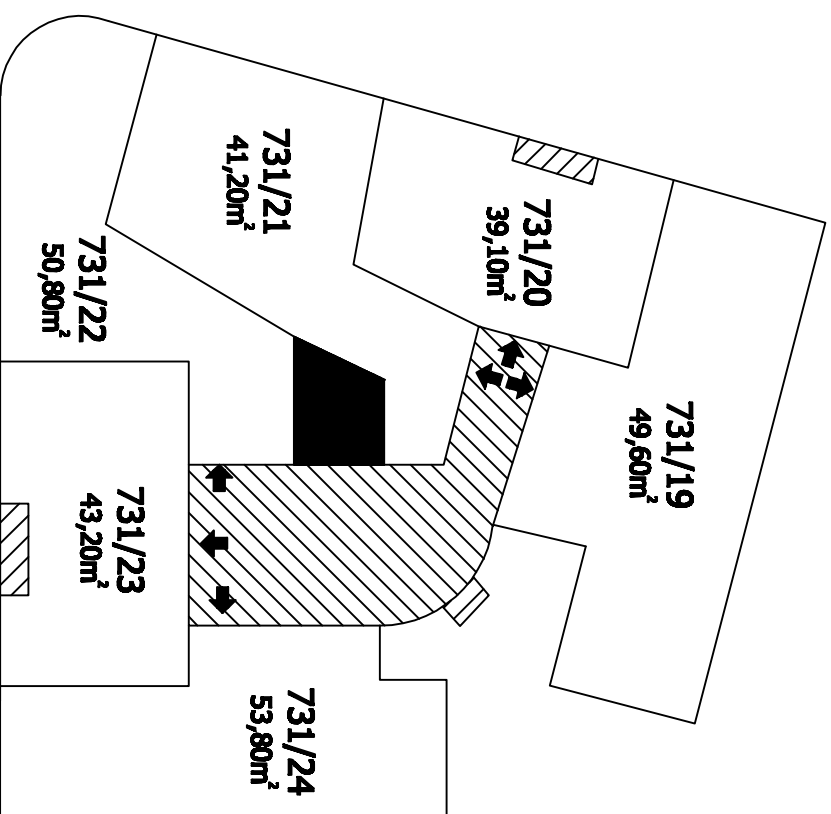

**5.N.P.
Na Spojce 1**

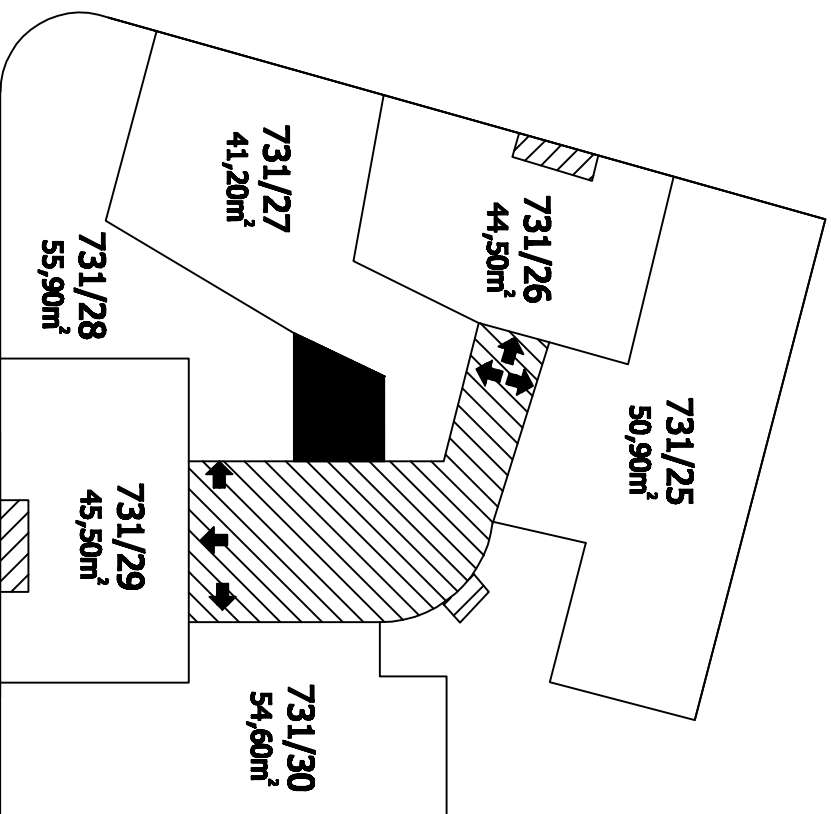

**6.N.P.
Na Spojce 1**

